

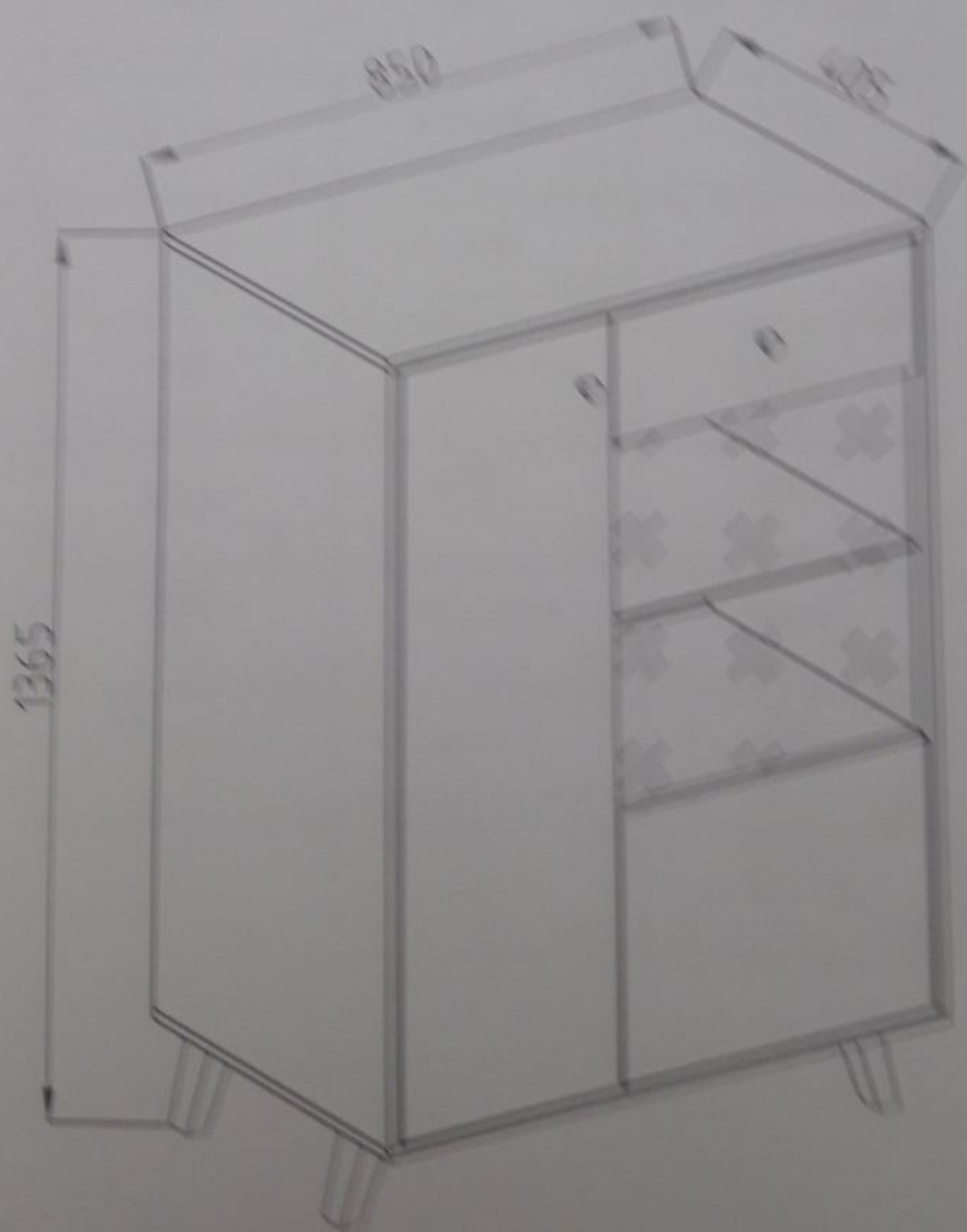

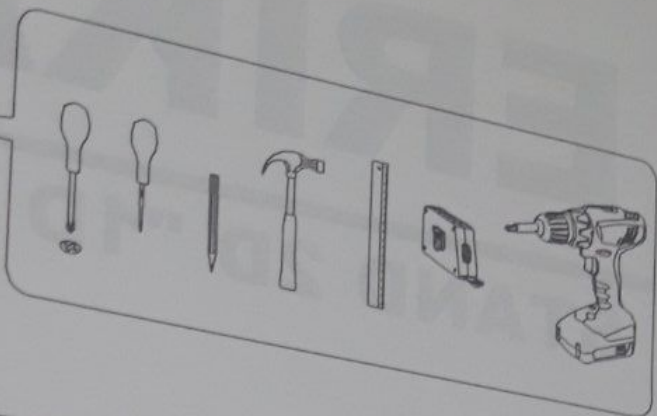













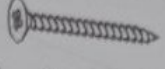



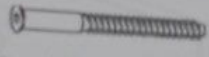

ERIKA

STAND 2D "1D 1V"

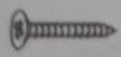



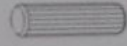



ERIKA

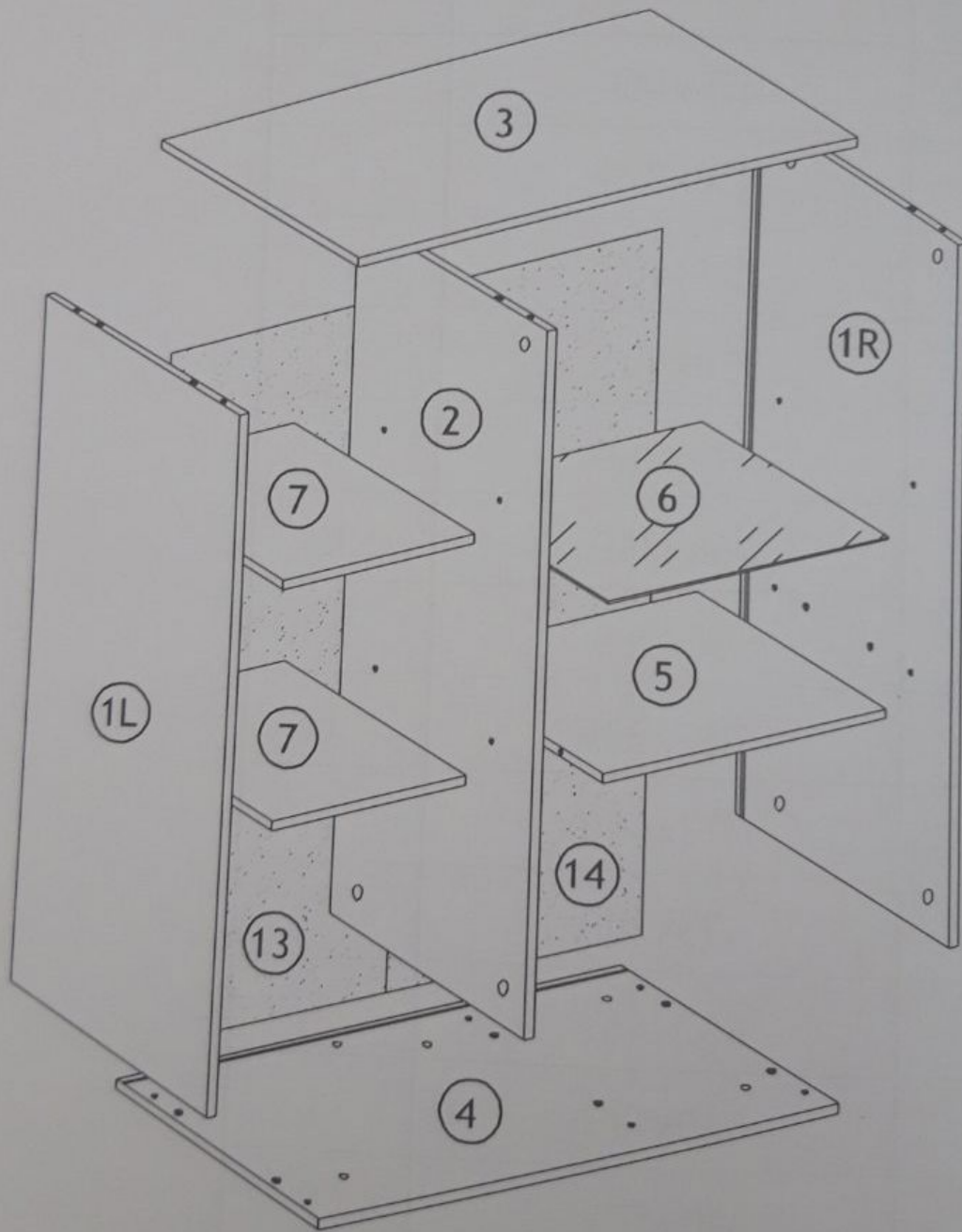



 L3  x5	 F2 6,3*13mm x10	 E10 4*16mm x10
 I22 x2	 E12 4*35mm x2	 U6 x2
 U7 x6	 Ea2 4*16mm x6	 J1 5*16mm x8
 J3 x4	 B2 6,8*70mm x4	 B ϕ 12mm x9
 U5 20*20mm x4	 H2 x12	 O1 x5
 E3 3*20mm x5	 C1 6*43mm x16	 D1 15/16 x16
 D ϕ 20mm x16	 B1 6,3*50mm x5	 A1 8*30mm x16
 R4 N4 x1	 K17 x4	

No	a*b	x
1L+R	1158x404	2
2	1158x374	1
3	850x405	1
4	850x405	1
5	470x360	1
6	466x360	1
7	330x360	2
8	1152x334	1
9/1	473x400	1
9/2	473x200	1
10	662x462	1
11	560x175	1
12	180x175	1
13	1167x342	1
14	1167x482	1
15	L - 1156	1

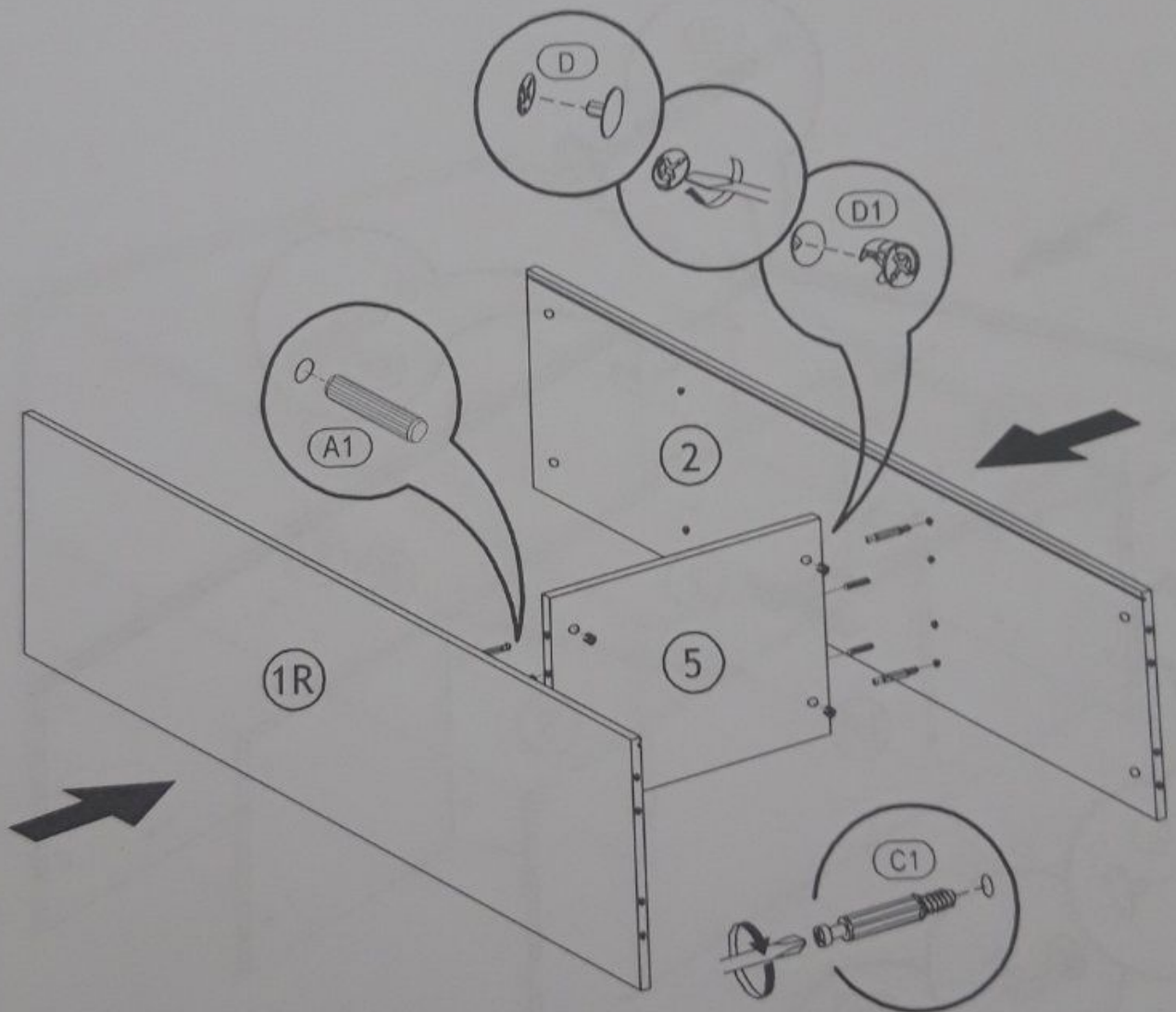

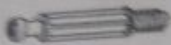



 C1 6*4 3mm x4	 A1 8*30mm x4	 D1 15/16 x4
 D ϕ 20mm x4		

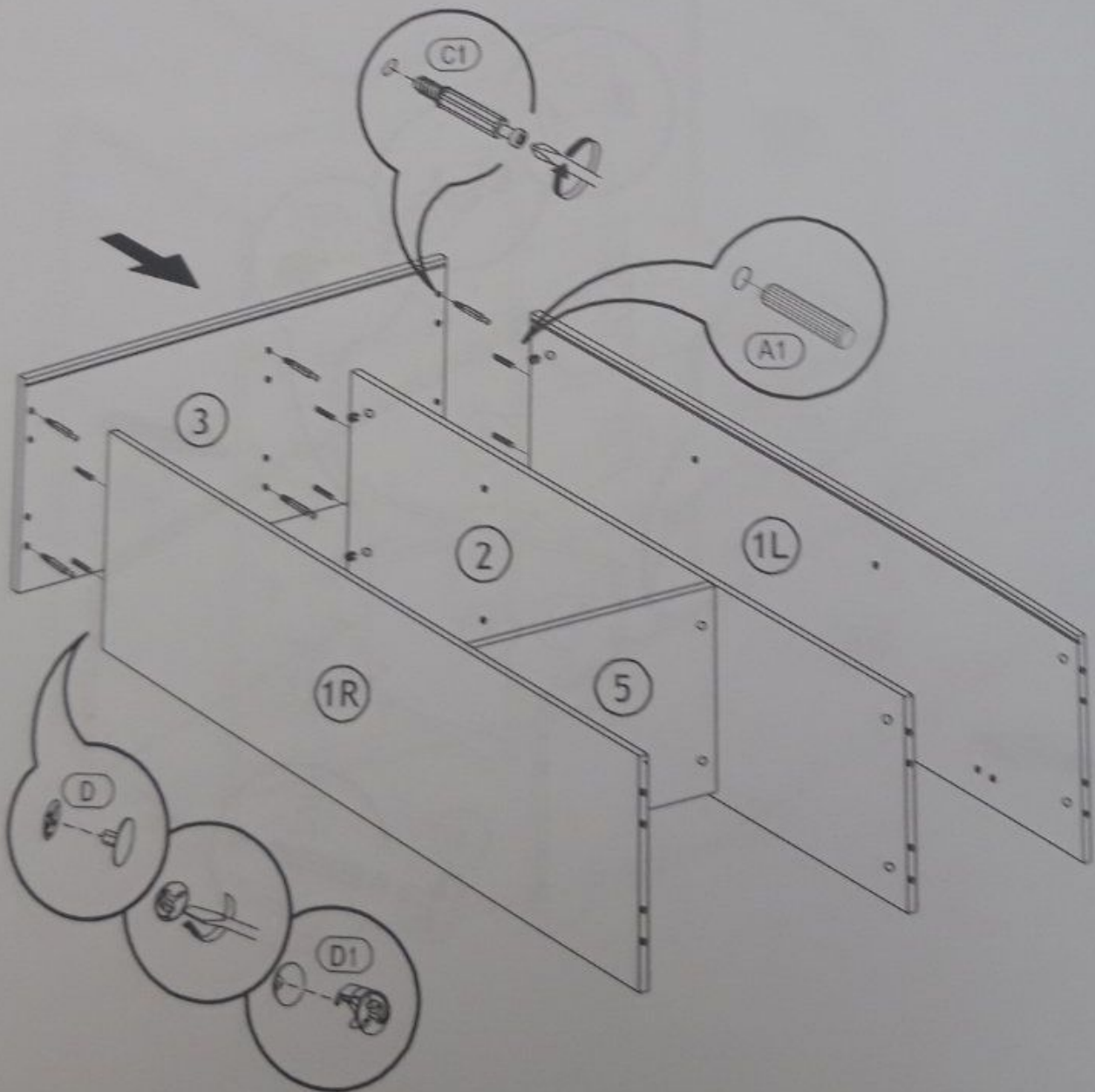

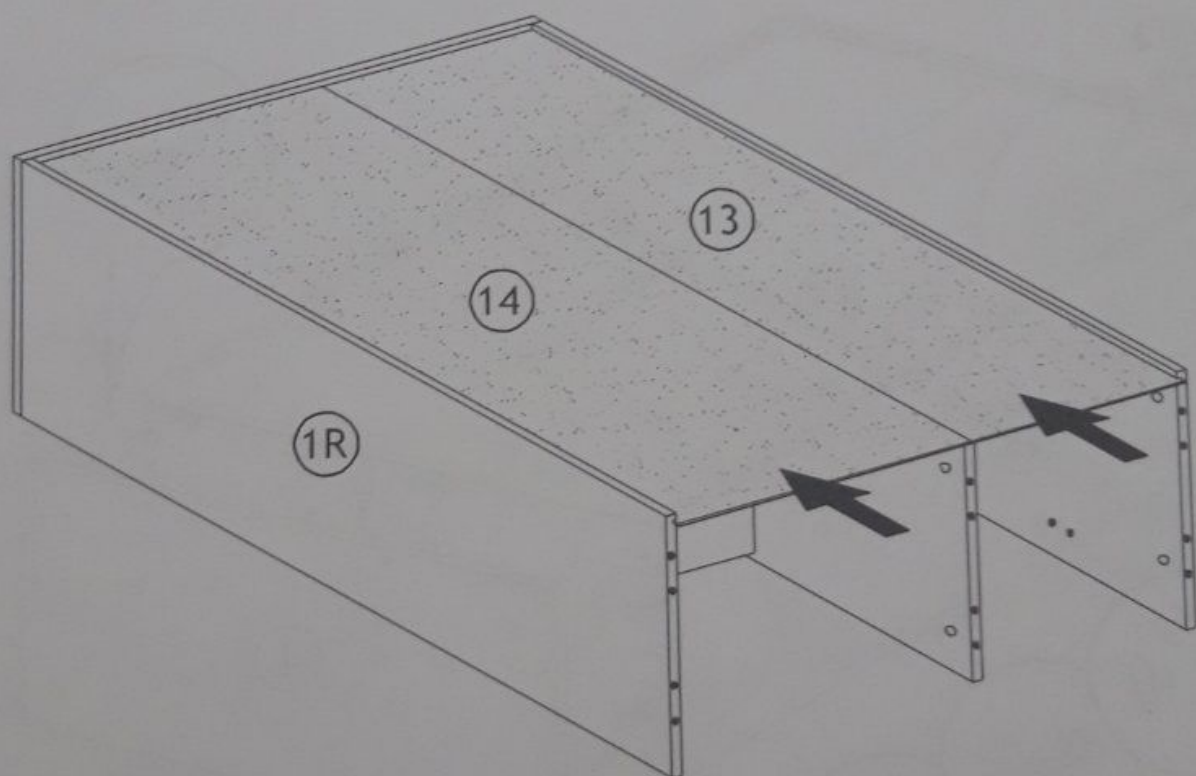

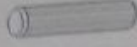

 (C1) 6*4,3mm x6	 (A1) 8*30mm x6	 (D1) 15/16 x6
 (D) ϕ 20mm x6		



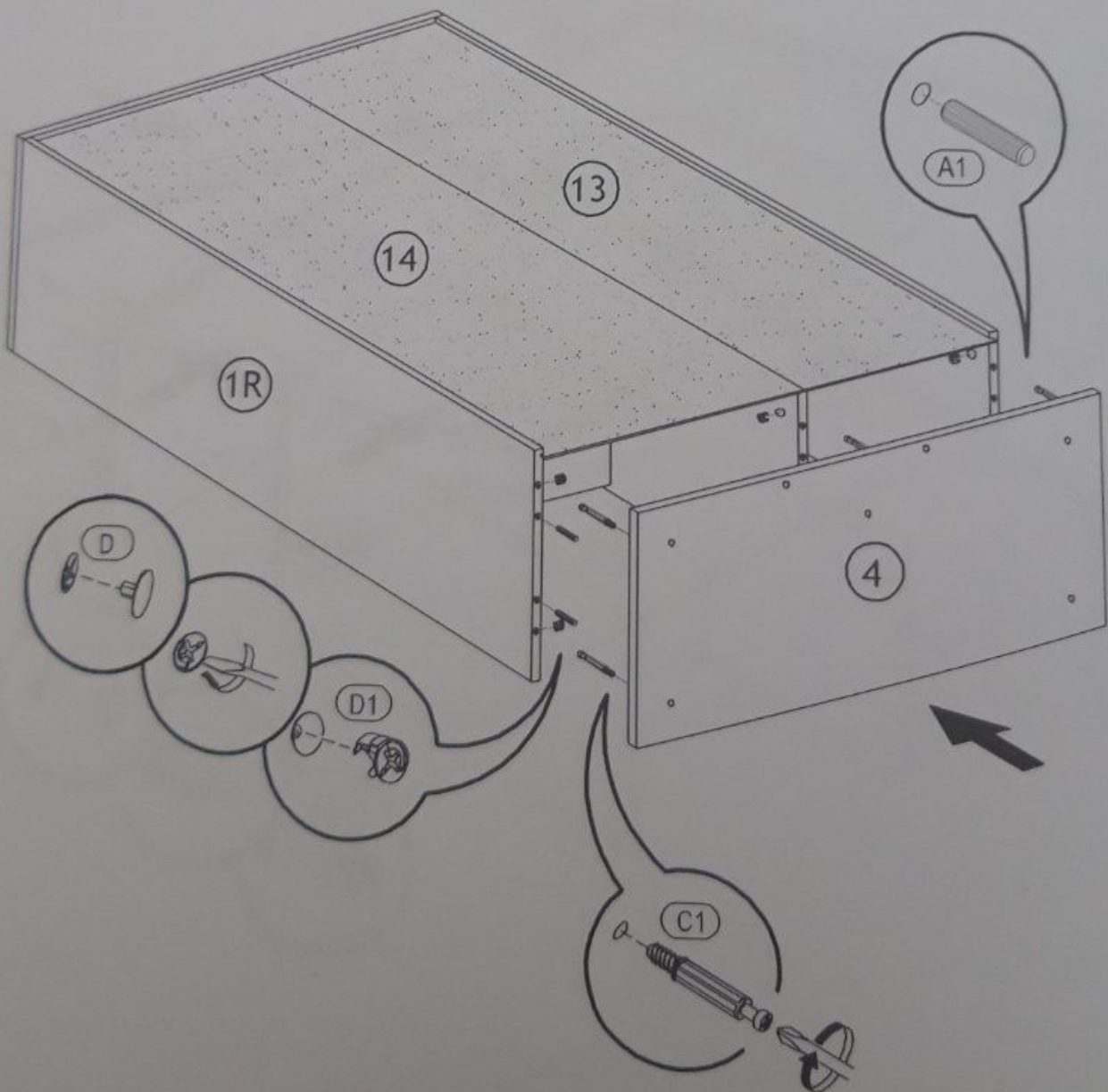





 (C1) 6*43mm x6	 (A1) 8*30mm x6	 (D1) 15/16 x6
 (D) ϕ 20mm x6		

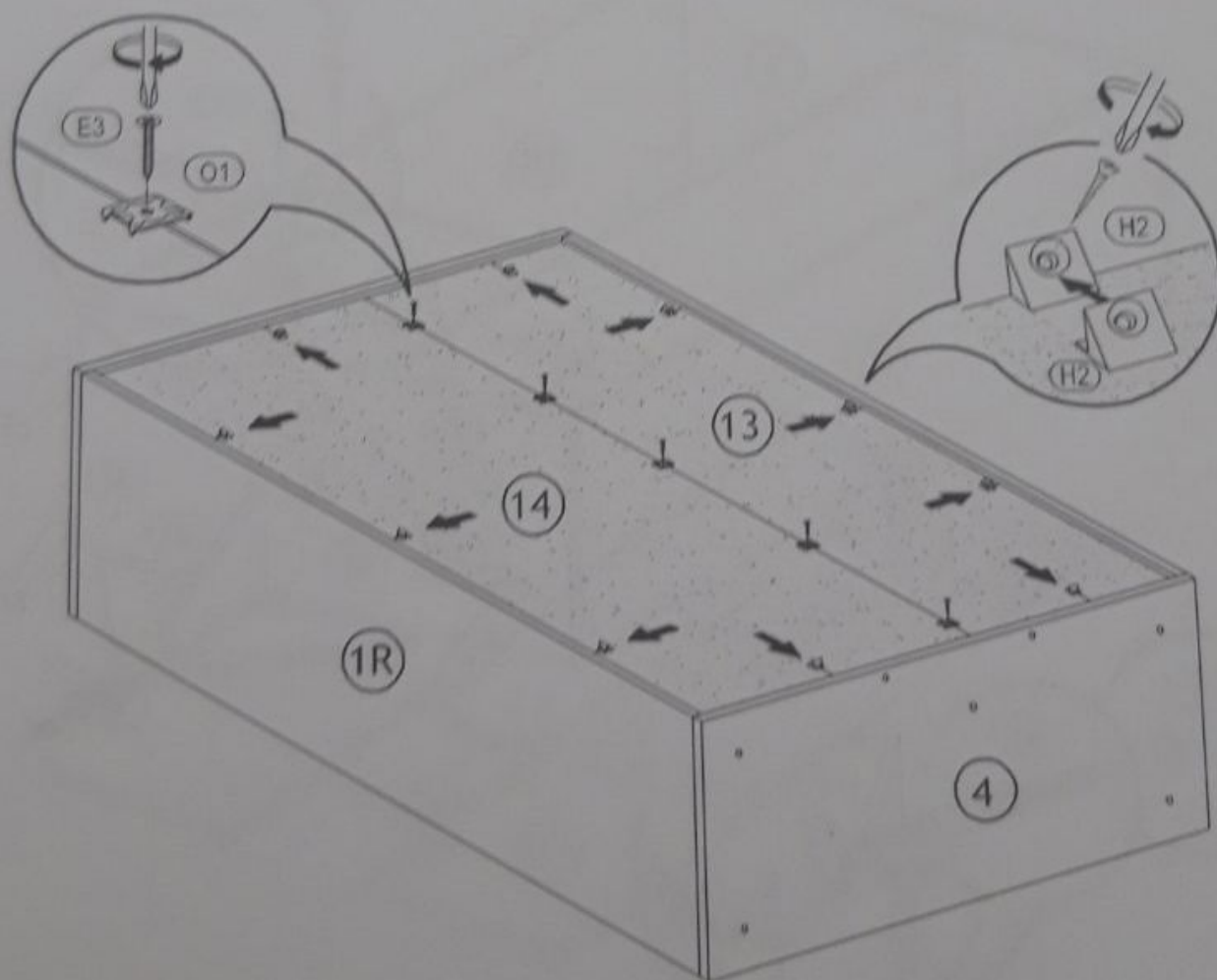

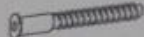

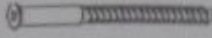

 <p>(H2) x10</p>	 <p>(E3) 3*20mm x5</p>	 <p>(O1) x5</p>
---	---	--

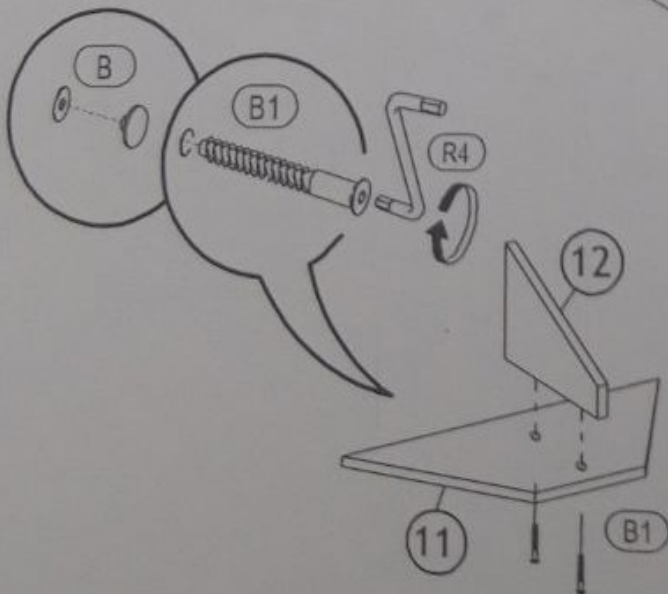
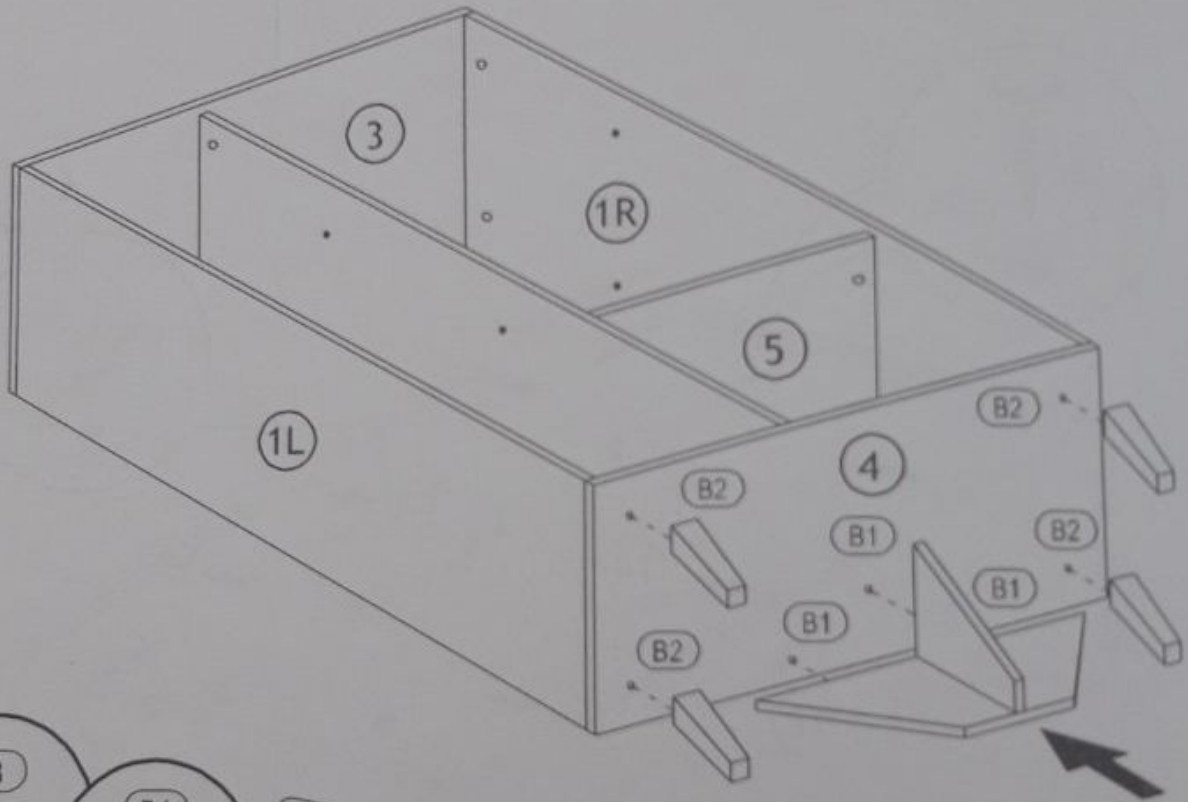

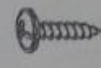

 B1 6,3*50mm x5	 B ϕ 12mm x9	 B2 6,8*70mm x4
 K17 x4		

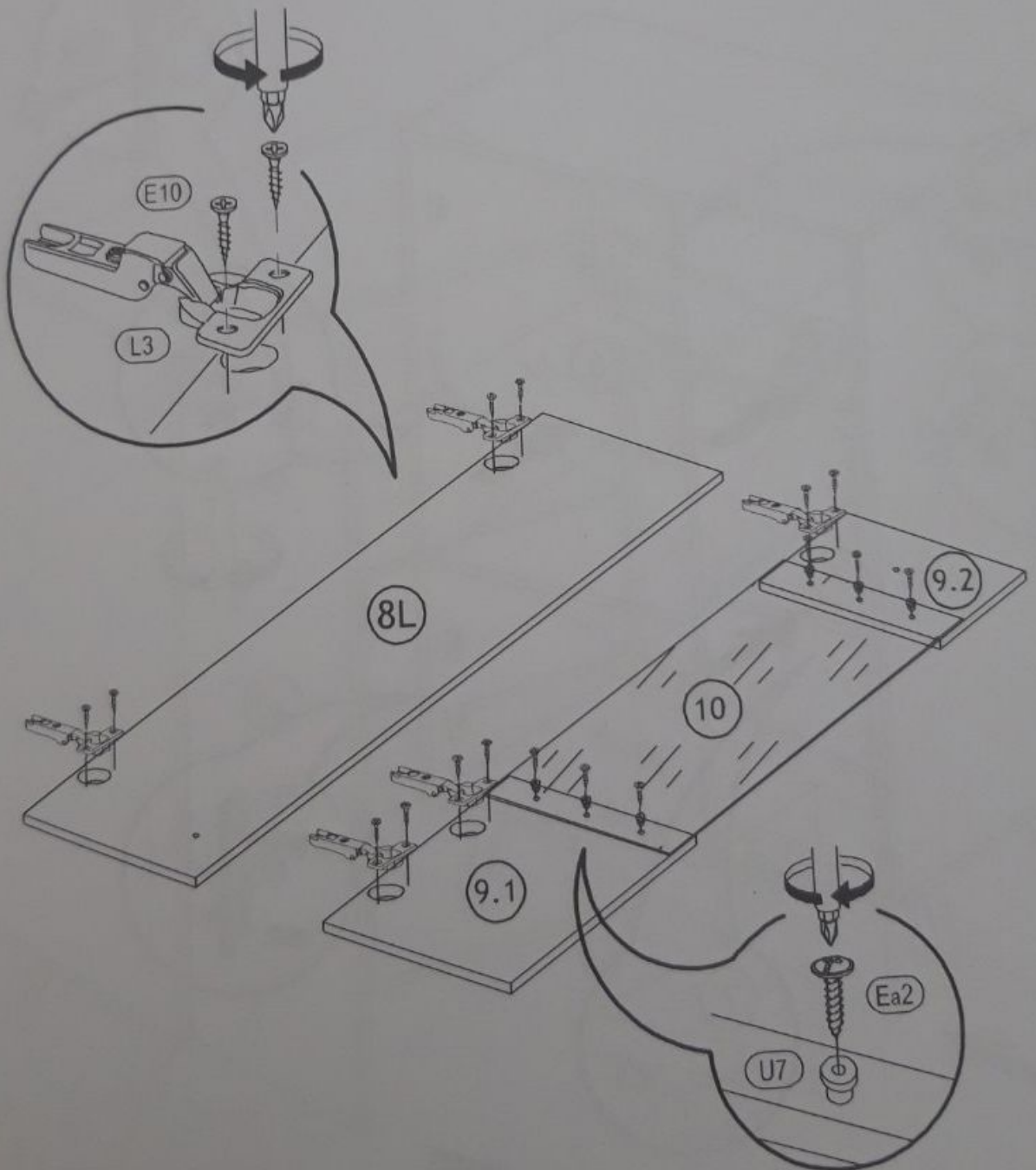

 <p>(L3) x5</p>	 <p>(E10) 4*16mm x10</p>	 <p>(Ea2) 4*16mm x6</p>
 <p>(U7) x6</p>		

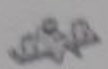

 (J1) 5*16mm x8	 (J3) x4	 (F2) 6,3*13mm x10
 (L3) x5		

